

CUBICO 22

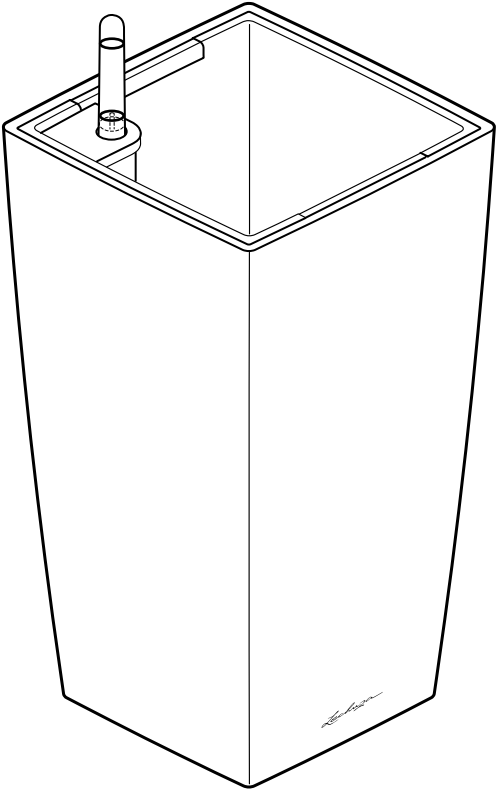

Item no: 13160 | 13161 | 13162 | 13164 | 18460 | 18461
18463 | 18464 | 18468 | 18469 | 18479

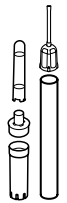
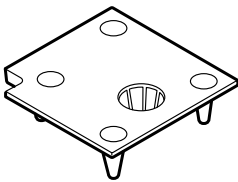
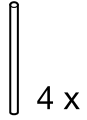
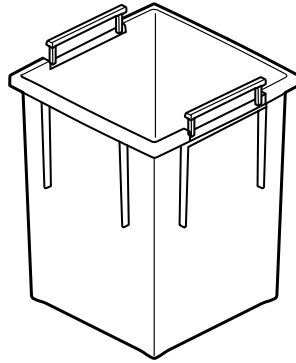
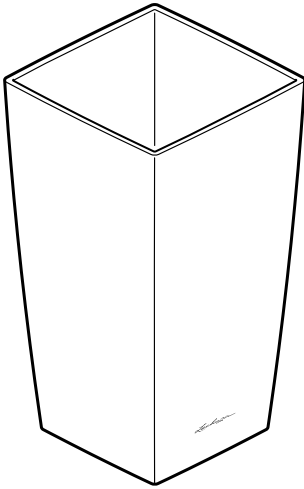

Indoor

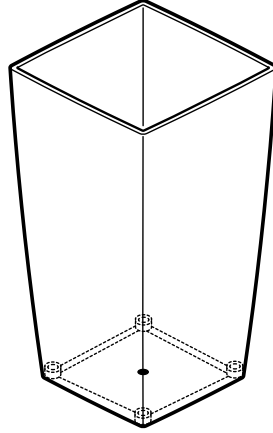
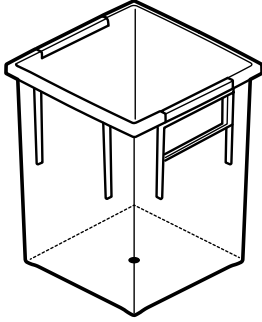

Outdoor

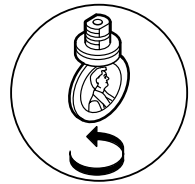
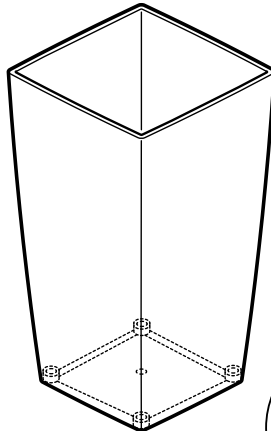
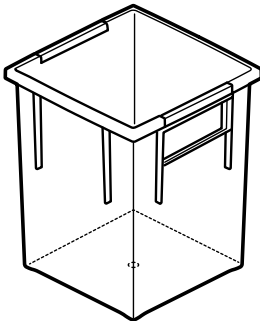
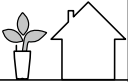

1

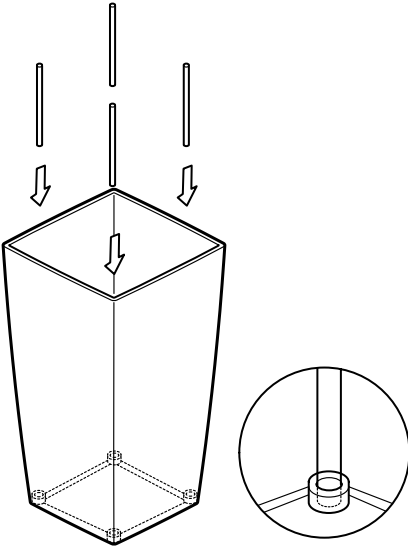

2

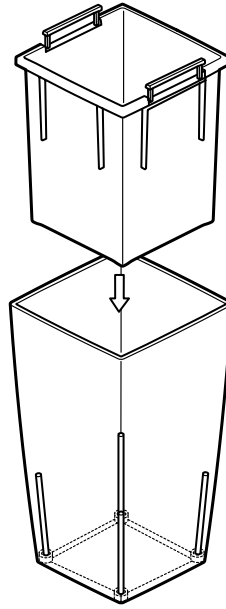

3

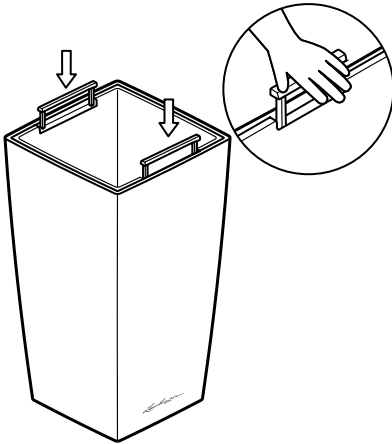

4

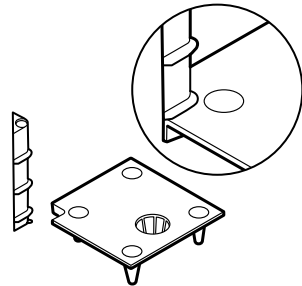

5

a

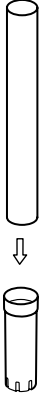

b

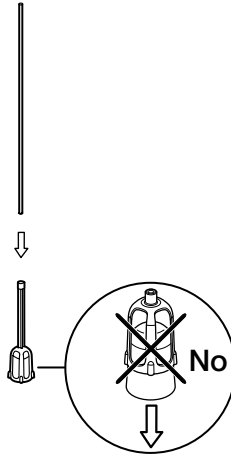

c

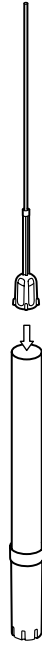

d



e

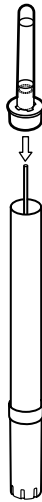

6

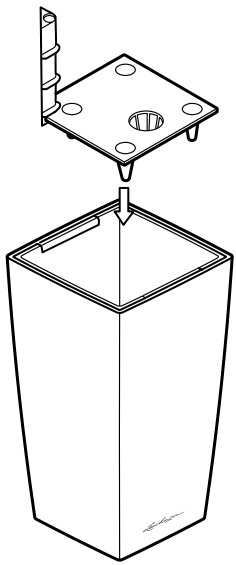

7

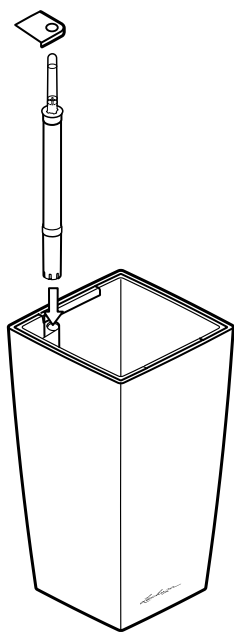

8

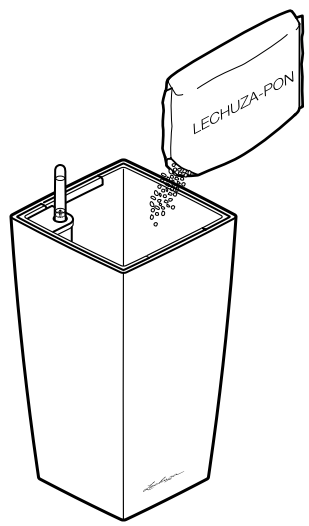

9

